

# NomoLine™

No-moisture sampling lines for intubated and non-intubated patients in low- and high-humidity applications



Advanced technology enables cost-effective, hassle-free sidestream capnography and gas monitoring

# NomoLine

NomoLine technology eliminates common problems associated with conventional sidestream gas analysis. Incorporating a unique, patented polymer, NomoLine allows water in the sampling line to evaporate into the surrounding air, while leaving oxygen, carbon dioxide, and anaesthetic gases unaffected, eliminating the need for a water trap and issues related to their handling. Designed for low-flow applications, with functionality in any orientation, NomoLine sampling lines can be used in a variety of clinical scenarios on both intubated and non-intubated adult, paediatric, and infant patients, in both low- and high-humidity configurations.



A selection of convenient, cost-effective single-patient-use products

## Features

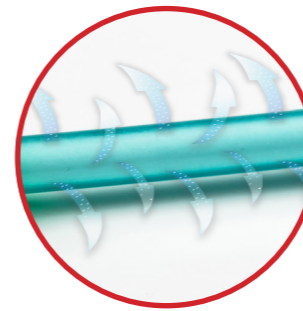

- > **Feature:** Patented polymer collects and removes water in the sampling line
- > **Benefit:** Extends product life and eliminates the need for a water trap

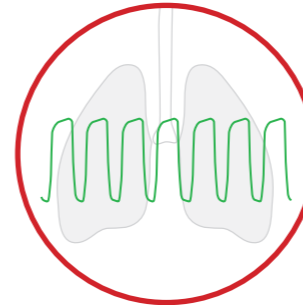

- > **Feature:** Designed for low tidal volumes and high breath rates
- > **Benefit:** Suitable for a wide range of clinical applications

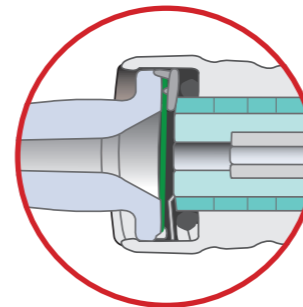

- > **Feature:** Hydrophobic bacteria filter
- > **Benefit:** Protects the ISA™ module from bacteria and water intrusion

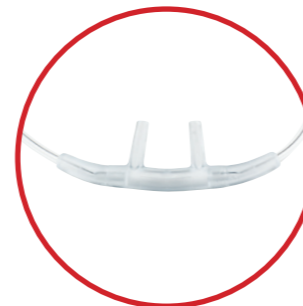

- > **Feature:** Cannulas with soft, ergonomically curved design
- > **Benefit:** Greater patient comfort



- > **Feature:** Leak-free, click-in gas sampling port connector
- > **Benefit:** Easy-to-use sampling lines



## NomoLine LH (Low-Humidity) Single-Patient-Use Sampling Lines

Single-patient-use sampling lines for short-term applications in low-humidity conditions.  
Available for intubated and non-intubated patients.

### NON-INTUBATED PATIENTS

Ordering Information: Box of 25, single-patient use



#### NomoLine LH Nasal CO2 Cannula

Key Applications: EMS, ED



#### NomoLine LH Nasal CO2 Cannula with O2 Delivery

Key Applications: EMS, ED



Adult	PN 3817
Paediatric	PN 3818
Infant	PN 3819

Adult with O2	PN 3820
Paediatric with O2	PN 3821



#### NomoLine LH Nasal/Oral CO2 Cannula

Key Applications: Procedural sedation, critical care, sleep lab, EP, EMS, ED, cath lab



#### NomoLine LH Nasal/Oral CO2 Cannula with O2 Delivery

Key Applications: Procedural sedation, critical care, sleep lab, EP, EMS, ED, cath lab



Adult	PN 3822
Paediatric	PN 3823

Adult with O2	PN 3824
Paediatric with O2	PN 3825



#### NomoLine LH Single Nasal Prong CO2 Cannula

Key Applications: EMS, ED



Adult single prong	PN 3826
--------------------	---------

### INTUBATED PATIENTS

Ordering Information: Box of 25, single-patient use

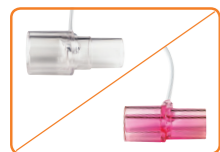

#### NomoLine LH Airway Adapter Set

Key Applications: Critical care  
Color coded Infant Airway Adapter Set: Pink



Adult/Paediatric, 2 m	PN 3814
Adult/Paediatric, 3 m	PN 3815
Infant, 2 m	PN 3816



## NomoLine HH (High-Humidity) Single-Patient-Use Sampling Lines

Single-patient-use sampling lines for long-term applications in high-humidity conditions.  
Available for intubated and non-intubated patients.

### NON-INTUBATED PATIENTS

Ordering Information: Box of 25, single-patient use



#### NomoLine HH Nasal CO2 Cannula

Key Applications: Critical care, sleep lab, long-term pain management



#### NomoLine HH Nasal CO2 Cannula with O2 Delivery

Key Applications: Critical care, sleep lab, long-term pain management



Adult	PN 3830
Paediatric	PN 3831
Infant	PN 3832

Adult with O2	PN 3833
Paediatric with O2	PN 3834



#### NomoLine HH Nasal/Oral CO2 Cannula

Key Applications: Critical care, sleep lab, long-term pain management



#### NomoLine HH Nasal/Oral CO2 Cannula with O2 Delivery

Key Applications: Critical care, sleep lab, long-term pain management



Adult	PN 3835
Paediatric	PN 3836

Adult with O2	PN 3837
Paediatric with O2	PN 3838



#### NomoLine HH Single Nasal Prong CO2 Cannula

Key Applications: Critical care, sleep lab, long-term pain management



Adult single prong	PN 3839
--------------------	---------

### INTUBATED PATIENTS

Ordering Information: Box of 25, single-patient use

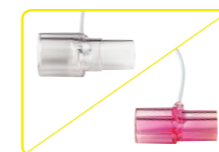

#### NomoLine HH Airway Adapter Set

Key Applications: OR, EMS, ED  
Color coded Infant Airway Adapter Set: Pink



Adult/Paediatric, 2 m	PN 3827
Adult/Paediatric, 3 m	PN 3828
Infant, 2 m	PN 3829



## How NomoLine Works

- > Gas and condensed moisture from the patient's expired breath enters the Nomo Section through the gas sample tube
- > Condensed moisture and aspirated water are separated and collected using a hydrophilic absorbent
- > When the capacity of the hydrophilic absorbent is reached, the sampling line should be replaced
- > A hydrophobic bacteria filter protects the gas module from water intrusion and cross-contamination



Nomo Section

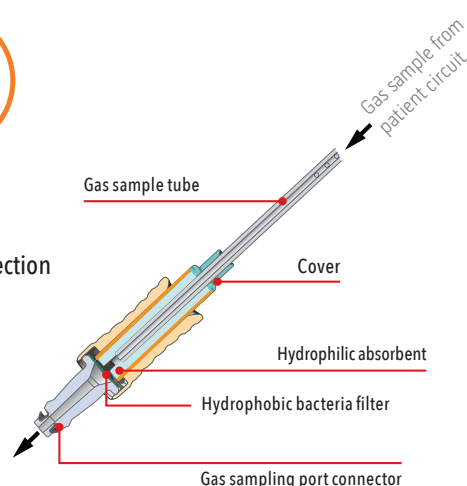

Nomo Section

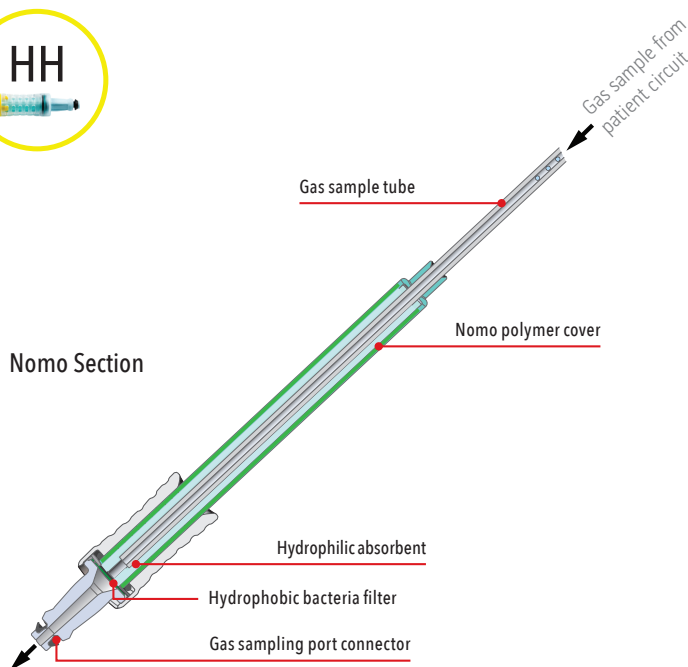

- > Gas and condensed moisture from the patient's expired breath enters the Nomo Section through the gas sample tube
- > Condensed moisture and aspirated water are separated and collected using a hydrophilic absorbent
- > Water molecules are diffused from the hydrophilic absorbent through the Nomo polymer cover
- > Long-term use is possible as the water diffused through the Nomo polymer cover continuously evaporates into the surrounding air
- > A hydrophobic bacteria filter protects the gas module from water intrusion and cross-contamination

## NomoLine Specifications

Standard length	2 m
Inline bacteria filter	BFE ≥ 99.9%
Tubing inner diameter	1 mm
Supplementary oxygen delivery	up to 5 l/min
Airway Adapter dead space	
Adult/Paediatric	≤ 6 ml
Infant	≤ 0.7 ml
Material	Not made with natural rubber latex

For professional use. See instructions for use for full prescribing information, including indications, contraindications, warnings, and precautions.